

## LV55K Series 3.3 V LVDS Clock Oscillators

November 2018



- Pletronics' LV55K Series is a quartz crystal controlled precision square wave generator with LVDS output.
- Improved phase noise performance.
- Tape and Reel or cut tape packaging is available.
- 3.2 x 5 mm LCC Ceramic Package
- Enable/Disable Function on pad 1
- Disable function includes low standby power mode
- 3<sup>rd</sup> Overtone Crystals used
- Improved circuit to minimize oscillator issues such as multi-mode output signal.
- Lowest Jitter Product

**\* BEST OPTION FOR LOW JITTER REQUIREMENTS  
50 fS Jitter 12.0 KHz to 20.0 MHz @156.25 MHz**

**Pletronics Inc. certifies this device is in accordance with the  
RoHS 6/6 (2011/65/EC) and WEEE (2002/96/EC) directives.**

Pletronics Inc. guarantees the device does not contain the following:

Cadmium, Hexavalent Chromium, Lead, Mercury, PBB's, PBDE's

Weight of the Device: 0.09 grams

Moisture Sensitivity Level: 1 As defined in J-STD-020D.1

Second Level Interconnect code: e4

### Absolute Maximum Ratings:

Parameter	Unit
V <sub>CC</sub> Supply Voltage	-0.5V to +4.6V
V <sub>i</sub> Input Voltage	-0.5V to V <sub>CC</sub> + 0.5V
V <sub>o</sub> Output Voltage	-0.5V to V <sub>CC</sub> + 0.5V

### Thermal Characteristics

The maximum die or junction temperature is 125°C

The thermal resistance junction to board is 30 to 50°C/Watt depending on the solder pads, ground plane and construction of the PCB.

**Part Number:**

LV55	45	K	E	V	-125.0M	-XX	<b>Available Frequencies:</b> 100.0MHz  106.25MHz  125.0MHz  133.0MHz  156.25MHz  <b>Contact factory for other options</b>
<b>Packaging code or blank</b> <b>T250</b> = 250 per Tape and Reel <b>T500</b> = 500 per Tape and Reel <b>T1K</b> = 1000 per Tape and Reel							
<b>Frequency in MHz</b>							
<b>Supply Voltage V<sub>CC</sub></b> <b>V</b> = 3.3V ± 10%							
<b>Optional Enhanced OTR</b> <b>Blank</b> = Temp. range -10 to +70°C <b>C</b> = Temp. range -20 to +70°C <b>E</b> = Temp. range -40 to +85°C							
<b>Series Model</b>							
<b>Frequency Stability</b> <b>45</b> = ± 50 ppm <b>44</b> = ± 25 ppm <b>20</b> = ± 20 ppm							
<b>Series Model</b>							

**Part Marking:**

PFF.FFL

• YMDXXX

**Marking Legend:**

P = Pletronics

L = LVDS

FF.FF = Frequency in MHz

YMD = Date of Manufacture (year-month-day)

All other marking is internal factory codes

Specifications such as frequency stability, supply voltage and operating temperature range, etc. are not identified from the marking. External packaging labels and packing list will correctly identify the ordered Pletronics part number.

**Codes for Date Code YMD**

Code	6	7	8	9	0	Code	A	B	C	D	E	F	G	H	J	K	L	M
Year	2016	2017	2018	2019	2020	Month	JAN	FEB	MAR	APR	MAY	JUN	JUL	AUG	SEP	OCT	NOV	DEC

Code	1	2	3	4	5	6	7	8	9	A	B	C	D	E	F	G
Day	1	2	3	4	5	6	7	8	9	10	11	12	13	14	15	16
Code	H	J	K	L	M	N	P	R	T	U	V	W	X	Y	Z	
Day	17	18	19	20	21	22	23	24	25	26	27	28	29	30	31	

## Electrical Specification for 3.30V $\pm 5\%$ over the specified temperature range and the frequency range of 100.0 to 212.50 MHz

Item	Min	Typ	Max	Unit	Condition
Frequency Accuracy "45"	-50	-	+50	ppm	For all supply voltages, load changes, aging for 1 year, shock, vibration and temperatures
"44"	-25	-	+25		
"20"	-20	-	+20		
Output Waveform	LVDS				
Output High Level	-	1.43	1.60	V	
Output Low Level	0.90	1.10	-	V	
Output Symmetry	45	-	55	%	at 50% point of $V_{CC}$ (See load circuit)
Jitter <sup>1</sup>	-	50	-	ps RMS	12 KHz to 20 MHz from the output frequency @156.25 MHz
Output $T_{RISE}$ and $T_{FALL}$	-	0.3	1.0	ns	$V_{th}$ is 20% and 80% of waveform
$V_{CC}$ Supply Current ( $I_{CC}$ )	-	28	45	mA	
Enable/Disable Internal Pull-up	30	-	150	Kohm	
V disable	-	-	20	%Vcc	
V enable	80	-	-	%Vcc	
Output leakage Current	-10	-	+10	$\mu$ A	
Enable time	-	-	2	ms	Time for output to reach a logic state, the output frequency is correct at the specified Start Time.
Disable time	-	-	200	ns	Time for output to reach a high Z state
Start up time	-	-	3	ms	Time for output to reach specified frequency
Operating Temperature Range	-10	-	+70	$^{\circ}$ C	Standard Temperature Range
	-20	-	+70	$^{\circ}$ C	Extended Temperature Range "C" Option
	-40	-	+85	$^{\circ}$ C	Extended Temperature Range "E" Option
Storage Temperature Range	-55	-	+125	$^{\circ}$ C	
Standby Current $I_{CC}$	-	-	15	$\mu$ A	Pad 1 low, device disabled

<sup>1</sup> Jitter computed from phase noise data at 156.25MHz

Specifications with Pad 1 E/D open circuit unless stated otherwise

**Load Circuit**

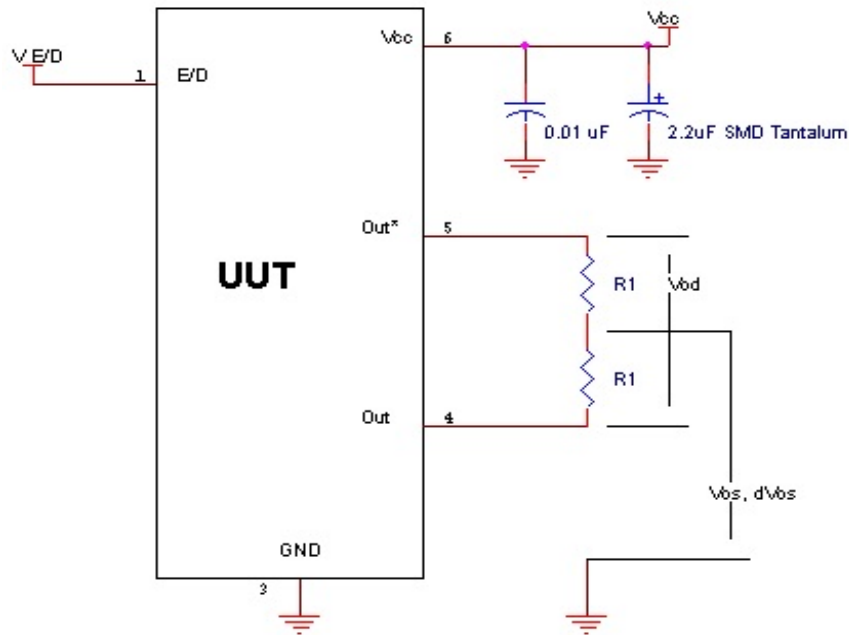

**Test Waveform**

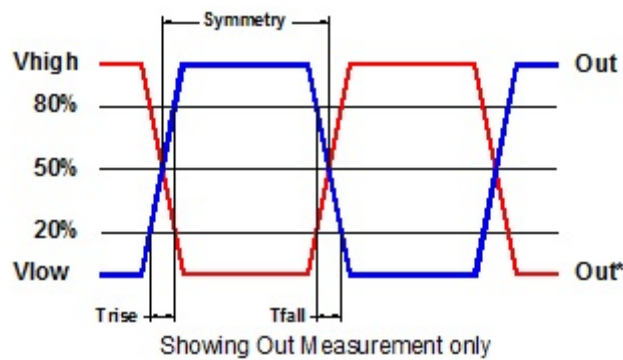

## Reliability: Environmental Compliance

Parameter	Condition
Mechanical Shock	MIL-STD-883 Method 2002, Condition B
Vibration	MIL-STD-883 Method 2007, Condition A
Solderability	MIL-STD-883 Method 2003
Thermal Shock	MIL-STD-883 Method 1011, Condition A

## ESD Rating

Model	Minimum Voltage	Conditions
Human Body Model	1500	MIL-STD-883 Method 3115
Charged Device Model	1000	JESD 22-C101

## Package Labeling

Label is 1" x 2.6" (25.4mm x 66.7mm)  
Font is Courier New  
Bar code is 39-Full ASCII

Label is 1" x 2.6" (25.4mm x 66.7mm)  
Font is Arial

<b>P/N:</b>	
	LV5545KV-156.25M
<b>Customer P/N:</b>	
	12345678
<b>Qty:</b>	
	1000
<b>D/C</b>	
	6KX-SG
MSL: 1	

<b>RoHS Compliant</b>
2nd LvL Interconnect
Category=e4
Max Safe Temp=260C for 10s 2X Max

## Mechanical:

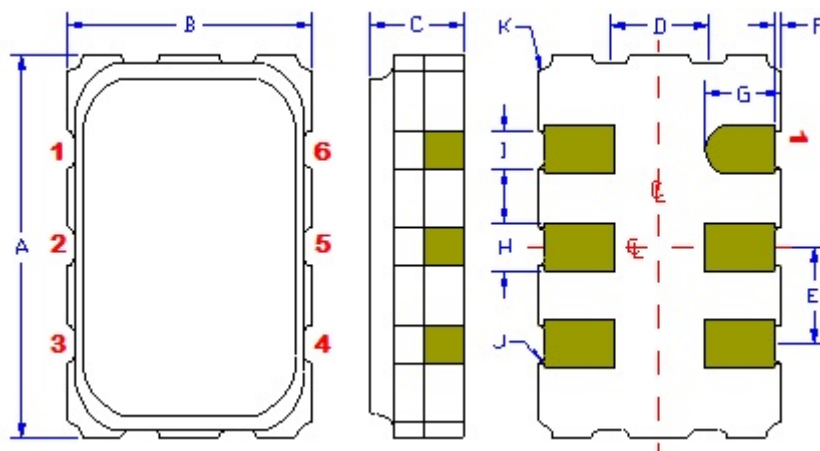

	Inches	mm
A	0.197 $\pm$ 0.006	5.00 $\pm$ 0.15
B	0.125 $\pm$ 0.006	3.20 $\pm$ 0.15
C	0.053 max	1.35 max
D <sup>1</sup>	0.050	1.27
E <sup>1</sup>	0.050	1.27
F <sup>1</sup>	0.004	0.10
G <sup>1</sup>	0.039	1.00
H <sup>1</sup>	0.025	0.63
I <sup>1</sup>	0.020	0.50
J <sup>1</sup>	0.004R	0.10R
K <sup>1</sup>	0.008R	0.20R

### Contacts:

Gold 11.8 to 39.4  $\mu$ mches (0.3 to 1.0 $\mu$ m)  
over  
Nickel 50 to 350  $\mu$ mches (1.27 to 8.89  $\mu$ m)

<sup>1</sup> Typical dimensions

Not to Scale

Pad	Function	Note
1	Output Enable/Disable	When this pad is not connected the oscillator shall operate. When this pad is <0.30 volts, the output will be inhibited (high impedance state.) Recommend connecting this pad to V <sub>CC</sub> if the oscillator is to be always on.
2	No connect	There is no internal connection to this pad
3	Ground (GND)	
4	Output	Both outputs must be terminated and biased for proper operation. The ideal termination is 50 ohms connected to 2.0V below the Supply Voltage.
5	Output*	
6	Supply Voltage (V <sub>CC</sub> )	Recommend connecting appropriate power supply bypass capacitors as close as possible.

## Layout and application information

Recommend connecting Pad 1 and Pad 2 together to permit the design to accept Enable/Disable input on either pad

For Optimum Jitter Performance, Pletronics recommends:

- a ground plane under the device
- no large transient signals (both current and voltage) should be routed under the device
- do not layout near a large magnetic field such as a high frequency switching power supply
- do not place near piezoelectric buzzers or mechanical fans.

## Reflow Cycle (typical for lead free processing)

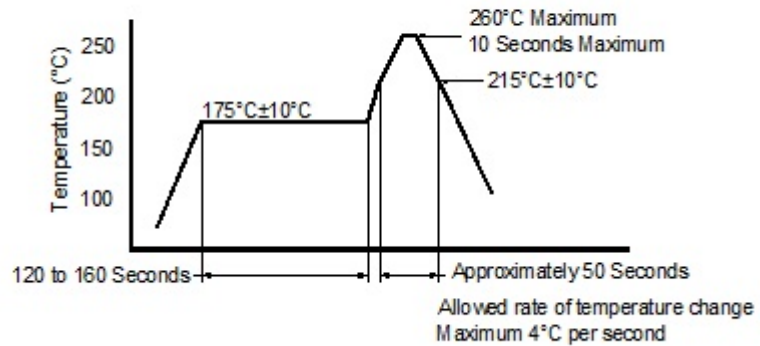

The part may be reflowed 3 times without degradation.

## Tape and Reel: available for quantities of 250 to 1000 per reel, cut tape for < 250

Constant Dimensions Table 1								
Tape Size	D0	D1 Min	E1	P0	P2	S1 Min	T Max	T1 Max
8mm	1.5	1.0	1.75	4.0	2.0 ±0.05	0.6	0.6	0.1
12mm		1.5			2.0 ±0.1			
16mm		+0.1 -0.0			1.5			
24mm		1.5			1.5			

Variable Dimensions Table 2							
Tape Size	B1 Max	E2 Min	F	P1	T2 Max	W Max	Ao, Bo & Ko
16 mm	12.1	14.25	7.5 ± 0.1	8.0 ± 0.1	8.0	16.3	Note 1

Note 1: Embossed cavity to conform to EIA-481-B Dimensions in mm Not to scale

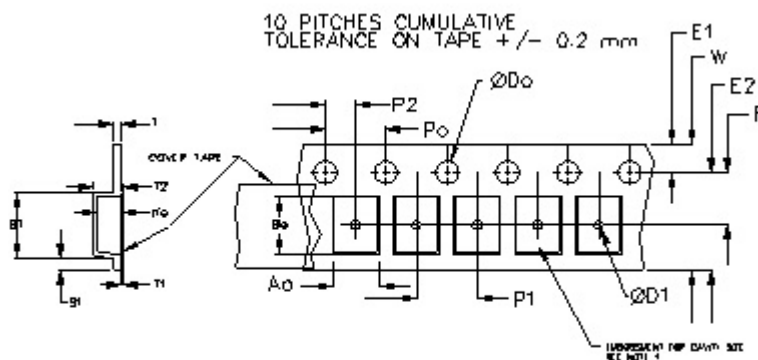
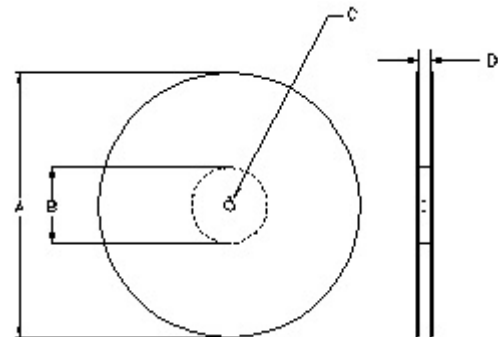

		REEL DIMENSIONS			Tape Width
A	inches	7.0	10.0	13.0	
	mm	177.8	254.0	330.2	
B	inches	2.50	4.00	3.75	
	mm	63.5	101.6	95.3	
C	mm	13.0 +0.5 / -0.2			
D	mm	16.4 +2.0 -0.0	16.4 +2.0 -0.0	16.4 +2.0 -0.0	16.0

Reel dimensions may vary from the above

## IMPORTANT NOTICE

Pletronics Incorporated (PLE) reserves the right to make corrections, improvements, modifications and other changes to this product at anytime. PLE reserves the right to discontinue any product or service without notice. Customers are responsible for obtaining the latest relevant information before placing orders and should verify that such information is current and complete. All products are sold subject to PLE's terms and conditions of sale supplied at the time of order acknowledgment.

PLE warrants performance of this product to the specifications applicable at the time of sale in accordance with PLE's limited warranty. Testing and other quality control techniques are used to the extent PLE deems necessary to support this warranty. Except where mandated by specific contractual documents, testing of all parameters of each product is not necessarily performed.

PLE assumes no liability for application assistance or customer product design. Customers are responsible for their products and applications using PLE components. To minimize the risks associated with the customer products and applications, customers should provide adequate design and operating safeguards.

PLE products are not designed, intended, authorized or warranted to be suitable for use in life support applications, weapons, weapon systems or space applications, devices or systems or other critical applications that may involve potential risks of death, personal injury or severe property or environmental damage. Inclusion of PLE products in such applications is understood to be fully at the risk of the customer. Use of PLE products in such applications requires the written approval of an appropriate PLE officer. Questions concerning potential risk applications should be directed to PLE.

PLE does not warrant or represent that any license, either express or implied, is granted under any PLE patent right, copyright, artwork or other intellectual property right relating to any combination, machine or process which PLE product or services are used. Information published by PLE regarding third-party products or services does not constitute a license from PLE to use such products or services or a warranty or endorsement thereof. Use of such information may require a license from a third party under the patents or other intellectual property of the third party, or a license from PLE under the patents or other intellectual property of PLE.

Reproduction of information in PLE data sheets or web site is permissible only if the reproduction is without alteration and is accompanied by associated warranties, conditions, limitations and notices. Reproduction of this information with alteration is an unfair and deceptive business practice. PLE is not responsible or liable for such altered documents.

Resale of PLE products or services with statements different from or beyond the parameters stated by PLE for that product or service voids all express and implied warranties for the associated PLE product or service and is an unfair or deceptive business practice. PLE is not responsible for any such statements.

### Contacting Pletronics Inc.

Pletronics Inc.  
19013 36<sup>th</sup> Ave. West  
Lynnwood, WA 98036-5761 USA

Tel: 425-776-1880  
Fax: 425-776-2760  
E-mail: [ple-sales@pletronics.com](mailto:ple-sales@pletronics.com)  
URL: [www.pletronics.com](http://www.pletronics.com)

Copyright © 2018 Pletronics Inc.